

# KLAY-INSTRUMENTS B.V.

## INSTRUCTION MANUAL

Make sure you thoroughly understand the contents of this manual before installing and using the level switch.

### Vibra Switch "S"

LEVEL SWITCH



**MANUFACTURER:**

 **KLAY INSTRUMENTS B.V.**

Nijverheidsweg 5  
P.O. BOX 13

7991 CZ Dwingeloo  
7990 AA Dwingeloo

NETHERLANDS

TEL.: +31 521-591550  
FAX.: +31 521-592046  
E-MAIL: info@klay.nl

## CONTENTS

<b>SECTION</b>		<b>PAGE</b>
1	Operation	3/8
2	Technical data	3/8
2.1	General	3/8
2.2	Wire DC output, to drive relays PLC-S	4/8
2.3	Accessories	4/8
2.4	Orderingcode	5/8
2.5	Pressure- and temperature diagrams	5/8
2.6	Responstime when getting free	5/8
3	Installation	6/8
3.1	Switching point and switch differential	6/8
4	Electrical connections	7/8
4.1	Connection terminal output 3 (PNP)	7/8
4.2	Description terminal output, Dipswitch en Status LED	7/8
5	Adjusting	8/8
6	Maintenance	8/8
7	Warranty	8/8

## **1. OPERATION**

The Vibra-Switch "S" is a robust and compact **micro processor based** level switch based on a vibrating probe. The piezo crystal excited and kept in resonance by an electronic circuitry. The process liquid, when reaching the probes changes the frequency of the vibration. The vibration frequency in a liquid is lower than in air or gas.

The Vibra Switch "S" is suitable for all kind of liquids. Due to the high vibration frequency combined with the very rugged probe, the function will not be influenced by turbulence, air bubbles or system vibration.

The "density" on which the level switch has to operate is selectable by means of a switch. If the level switch is used on high viscosity fluids, the mounting position is very important. The position of the tuning forks have to be so that the fluid easily drop of.

A marking on the hexagonal neck on top of the process connection shows the position of the tuning forks.

The stainless steel electronics housing can be turned around to be able to get the cable gland in the right position independently from the tuning forks.

The indication of the switch is visible with a internal LED.

## **2. TECHNICAL DATA**

### **2.1 GENERAL**

<b>Vibra-Switch "S"</b>	
<b>Maximum pressure</b>	<b>40 bar</b>
<b>Probe length</b>	<b>47 mm, 100 mm, 200 mm up to 3 meters</b>
<b>Material wetted parts</b>	<b>AISI 316 Halar (ECTFE) coated (optional)</b>
<b>Liquid temperature range</b>	<b>See table in 2.6 and diagrams</b>
<b>Ambient temperature</b>	<b>See table in 2.6 and diagrams</b>
<b>Liquid density</b>	<b>≥ 0.7 kg/dm<sup>3</sup>      ≥ 1.0 kg/dm<sup>3</sup></b>
<b>Liquid viscosity</b>	<b>≤ 10.000 mm<sup>2</sup>/s (c St)</b>
<b>Response time</b>	<b>2 seconds</b>
<b>Output mode indication</b>	<b>Status LED</b>

### **2.2.3-WIRE DC OUTPUT, TO DRIVE RELAYS OR PLC-S**

Version		3 wire DC	
		Output 3	
Cable gland		PG 9	
Protection Grade		IP 68	
High/low mode setting		Switch selectable	
Density		Switch selectable	
Output		PNP, 3-wire	
Output protection		Reverse polarity, overcurrent and short circuit protection	
Supply voltage		12 ... 40 Vdc	
Consumption		< 0,6 W	
Voltage drop in switched-on state		< 4,5 Vdc	
Current load	max. continuous	$I_{max} = 350 \text{ mA DC} / U_{max} = 40 \text{ Vdc}$	
Residual current (in switched-off state)		< 100 $\mu\text{A}$	

### **2.3 ACCESSORIES**

Various hygienic process connections are available (milk coupling, tri clamp, etc). The standard process connection is 1" BSP thread.

Various weld-on nipples, also the standard 1" BSP weld- on nipple are available on request.

The 1" BSP hygienic weld-on nipples are available in two versions,  $\varnothing$  65 mm (article no. 10197) and  $\varnothing$  48 mm (article no. 10189).

## 2.4 ORDERING CODE

VIBRA SWITCH S

VSS	PROCES CONNECTION	CODE	LENGTH	CODE	OUTPUT	CODE
	1" BSP (Standard)	S	Short (47 mm)	47	3-wire (PNP)	3
	1" NPT	N	Standard (100 m)	100		
	Milk coupling DN 40 (DIN11851)	M(40)	0,2 tot 3 mtr.	200..3000		
	Milk coupling DN 50 (DIN11851)	M(50)				
	Tri clamp (2")	L(2")				
	Flange (Specify size)**	F				
	Other connections	X (...)				

## 2.5 PRESSURE AND TEMPERATURE DIAGRAMS

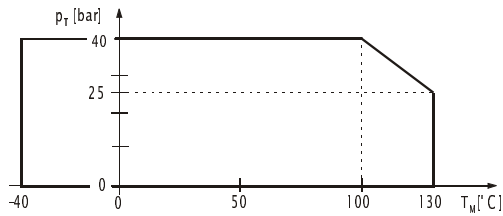

For all models

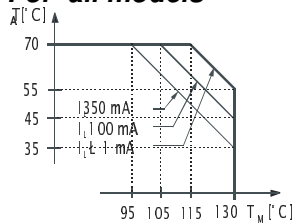

For 3-wire DC models (IL) load current

## 2.6 RESPONSE TIME DIAGRAM WHEN GETTING FREE

Response time

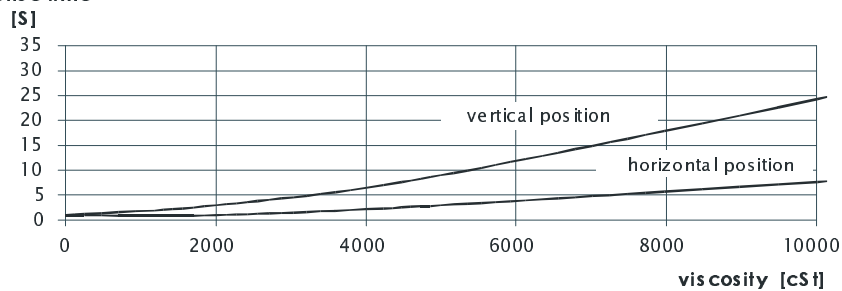

### **3. INSTALLATION**

For positioning the tuning forks, use the marking on the hexagonal neck.

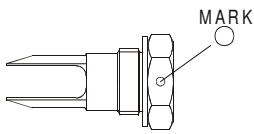

Use a TEFLON (PTFE) tape to aid the positioning of the fork-tine. If the fork-tine position is irrelevant, use the sealing ring provided. To mount in the mandrel use the provided o-ring and possibly the sealing ring.

#### *Low viscosity liquids*

On applications, where the vibrating probes are easily freed from the process medium, any of the mountings shown to the right is possible.

#### *High viscosity liquids*

On applications, where the vibrating probes are not freed easily from the process medium, the position of the tuning forks is extremely important. A vertical mounting position is strongly recommended.

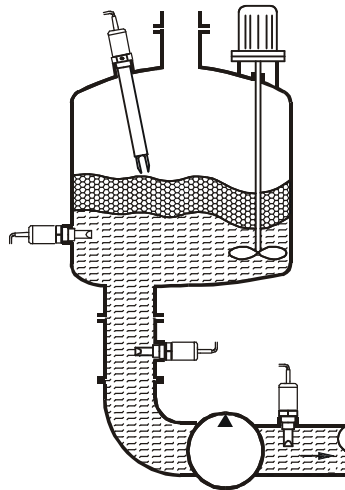

**Installing options**

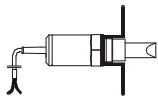

**Threaded version**

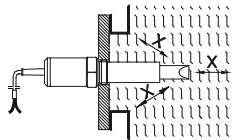
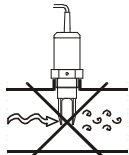

**Critical distances ( $x_{min} > 5 \text{ mm}$ )**

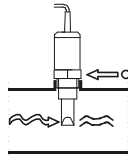

### **3.1 SWITCHING POINT AND SWITCH DIFFERENTIAL**

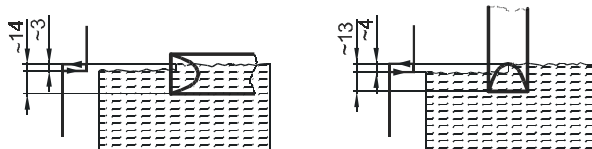

**(For water at 25°C)**

Switching point as well as the switch differential depends on liquid density and mounting position.

Fork-tunes must be parallel to the direction of flow.

## **4. ELECTRICAL CONNECTIONS**

### **4.1 CONNECTION TERMINAL OUTPUT 3 (PNP)**

**Power Supply: 12 - 40 Vdc**

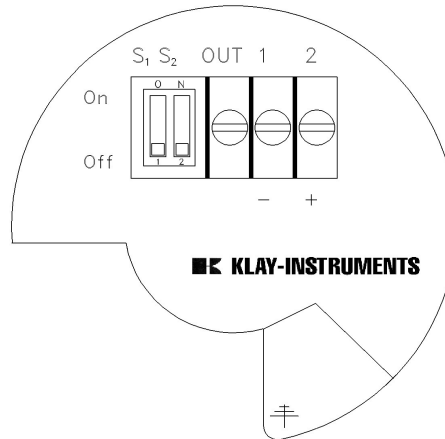

### **4.2 DESCRIPTION CONNECTION TERMINAL, DIPSWITCH AND STATUS LED**

<b>Terminal 2</b>	<b>: +</b>
<b>Terminal 1</b>	<b>: -</b>
<b>Terminal out</b>	<b>: PNP</b>
<b>S1 (on)</b>	<b>: Output n.c.</b>
<b>S1 (off)</b>	<b>: Output n.o.</b>
<b>S2 (on)</b>	<b>: High density</b>
<b>S2 (off)</b>	<b>: Low density</b>
<b>Led green</b>	<b>: Output n.o.</b>
<b>Led red</b>	<b>: Output n.c.</b>

## **5. ADJUSTMENT**

Check the connection of the wires and the position of vibrating probes. After connection and power up the level switch is operational.

Operating diagram of the Vibra Switch "S":

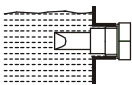
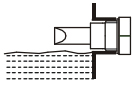
Power supply	Probe	Operating mode	Status LED	S1	Output
ON	 Immersed	High level	Red	Off	24 Vdc
		Low level	Green	On	0 Vdc
	 Free	Hoog niveau	Green	Off	0 Vdc
		Laag niveau	Red	On	24 Vdc

## **6. MAINTENANCE**

The Vibra-Switch "S" does not require routine maintenance. In some instances however, the sensor probe may need occasional cleaning to remove surface deposits. This must be carried out gently, without harming the tuning forks.

## **7. WARRANTY**

***The warranty is 1 year from purchase date.***

Klay Instruments B.V. assumes no liability for consequential damage of any kind due to use or misuse of the Vibra Switch.

Warranty will be given, to be decided by the manufacturer.

The Level Switch must be shipped prepaid to the factory on manufacturer's authorization.

### **NOTE:**

***Klay Instruments B.V. reserves the right to change its specifications at any time, without notice. Klay Instruments B.V. is not an expert in the customers process (technical field) and therefore does not warrant the suitability of its product for the application selected by the customer.***

### **NOTE:**

***The tuning forks should not be damaged.***

---

 **KLAY INSTRUMENTS B.V.**

Nijverheidsweg 5  
P.O. Box 13

7991 CZ Dwingeloo  
7990 AA Dwingeloo

The Netherlands

TEL.: 0521-591550  
FAX.: 0521-592046  
E-MAIL: info@klay.nl