



'INTELLIGENT' PRESSURE AND LEVEL TRANSMITTERS

For all industries

Series 4000



- ▶ ALL STAINLESS HOUSING
- ▶ EASY CALIBRATION WITHOUT TESTPRESSURE BY UNIQUE CONTROL BUTTON AND DISPLAY
- ▶ ACCURACY: 0.075%
- ▶ TURN DOWN 20:1
- ▶ GRAPHIC DISPLAY WITH BARGRAPH AND BACKLIGHT
- ▶ DISPLAY: PRESSURE TEMPERATURE AND BARGRAPH
- ▶ ACTIVE TEMPERATURE COMPENSATION
- ▶ DEVELOPMENT ACCORDING TO SIL2
- ▶ VARIOUS LINEARISATION FUNCTIONS
- ▶ ALL INDUSTRIAL PROCESS CONNECTIONS
- ▶ OPTION: HART® PROTOCOL



Description

The series 4000 is a complete line of 'High-end' Intelligent pressure and level transmitters with a **Stainless steel electronics housing**. The calibration / programming can be done very easy without testpressure by using the **Unique One Touch programming button** together with the Graphic display with backlight. The graphic display can indicate a number of chosen engineering units including the process temperature and the actual value in a bargraph. Damping times can be adjusted and a 4-20 mA current simulation can be performed. Various tankshapes for different tank linearisations are available. The series 4000 is fully temperature compensated and over 40 different process connections with flush diaphragm are available. Options include HART® protocol and ATEX  Ex ia approval (pending).

HART® is a registered trademark of the HART Communication Foundation.

Stainless steel electronics housing



7991 CZ Dwingeloo

Series 4000

Specifications

Accuracy	: 0.075% of adjusted span
Ranges	: 0-100 mBar to 0 – 100 bar
Turn down	: 20:1
Adjustment	: by One pushbutton and local display, without test pressure
Output	: 4-20 mA (option: HART® Protocol)
Supply	: 12 – 36 Vdc
Electrical connection	: M20 x 1.5 (2x)
Protection	: IP66 (option: IP68)
Process temperature	: -20°C to 80°C (option: 100°C)
Ambiant temperature	: -20°C to 70°C
Material wetted parts	: AISI 316 (option: Hastelloy C)
Electronic housing	: AISI 304 (option: AISI 316)
Process connections	: See ordercode at page 4

Adjustable points

P101	Zero adjustment (ZERO / 4 mA)
P102	Span adjustment (SPAN / 20 mA)
P103	Cancel mounting position effect
P104	Adjustment pressure unit
P105	Output 4-20 mA* or 20-4 mA
P106	Damping adjustment (0 - 25 sec.)
P107	Language: English*, Dutch, German, French or Russian
P108	Safety adjustment, Alarm and backlight
P109	Read out on display: Current, pressure unit, temp. or %.
P110	Current simulation (4-20 mA)
P111	Linearisation (various tankshapes)
P112	Internal warnings
P113	Adjustment overview

*= Factory setting

Graphic display with bargraph and backlight

Multi language: English, Dutch, German, French and Russian

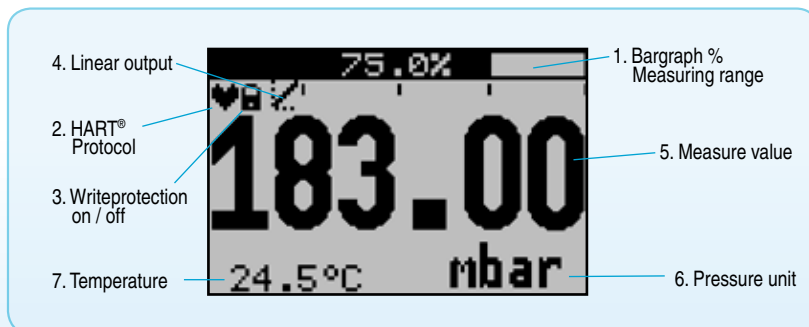

Code S

Pressure Spike protection

All pressure transmitters from series 4000 (SAN) with a range > 1 bar are carried out with one or two internal pressure dampers to protect the sensor against pressure spikes.



Unique 'One Touch Programming button'

The series 4000 (SAN) is carried out with a **unique control button**. This 'single button' can be used for all programming / calibration functions.



360° Revolving display



Code W33

With unique OneTouch Programming Button



Series 4000 SAN

Specifications

Accuracy	: 0.075% of adjusted span
Ranges	: 0-30 mBar to 0 – 100 bar
Turn down	: 20:1
Adjustment	: by One pushbutton and local display, without testpressure
Output	: 4-20 mA (option: HART® Protocol)
Supply	: 12 – 36 Vdc
Electrical connection	: M20 x 1.5 (2x)
Protection	: IP66 (option: IP68)
Process temperature	: -20°C to 100°C (145°C / 45 min)
Ambiant temperature	: -20°C to 70°C
Material wetted parts	: AISI 316 (option: Hastelloy C or Tantalum)
Electronic housing	: AISI 304 (option: AISI 316)
Process connections	: More than 40 ! See ordercode on page 4

Separate electronics

Series 4000-SAN is also available in a separated version.

Type: **4000-SAN-Cable(...m)-range-...**

Always specify the cable length, range and process connection. (See ordercode at page 4).



Easy Tank linearisation

Various tankshapes are already pre-programmed in the series 4000(SAN) which ensures a **very easy tank linearisation**.

The standard tank shapes are:

- Horizontal tank with flat end
- Horizontal tank with parabolic end
- Vertical tank with a spherical bottom
- Vertical tank with a conical bottom

In addition, a free linearization curve of up to 50 points is adjustable.

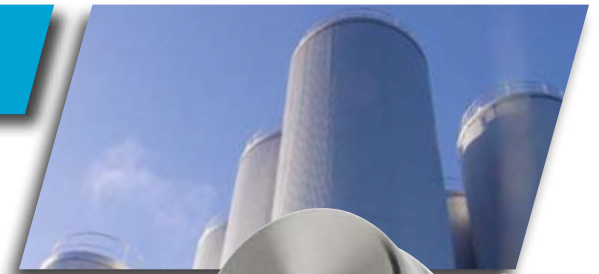

Code M



Code W



Code L

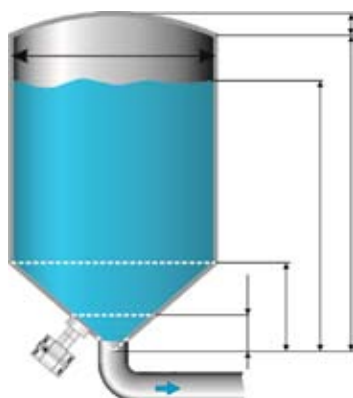
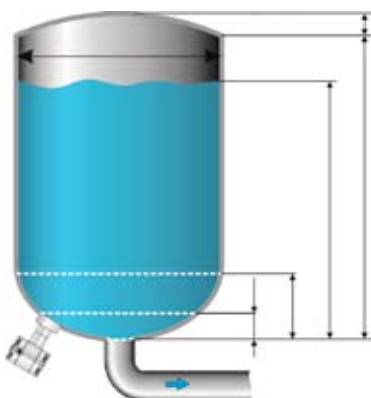

Ordering codes Series 4000 and 4000-SAN

SERIES 4000			Ordering code standard transmitter: 4000 -					
(info on page 2)			Ordering code with cable: 4000-Cable (....m) -					
Adjustable span range:		Max. overpressure (bar)	▲	▲	▲	▲	▲	▲
0 - 0,1	to 0 - 1,2 bar	10	20					
0 - 0,5	to 0 - 10 bar	50	30					
0 - 5	to 0 - 100 bar	200	40					
PROCESS CONNECTIONS:								
- Weld-on nipple diam. 33 mm. (flush diaphragm / pulp & paper)				W				
- G1" (1"BSP) threaded connection (flush diaphragm)				S				
- M44 x 1,25 (PMC, Rosemount, Vega)				X2				
- PASVE 1" connection (Valmet/Satron)				X12				
- Other process connections, specify X code				X..				
OPTIONS:								
- Transparent cover, display functions as local indicator.				I				
- Vacuum Ranges (Specify Relative or absolute) Compound ranges available (example -1 / +1 bar)					V			
- Intrinsically safe: ATEX II 1 G Ex ia IIC T4 (Pending)						Ex		
- HART® Protocol. HART 7 (= Factory setting), (HART 5 also selectable)								H

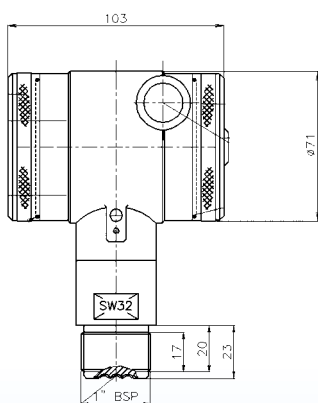

4000 - code S

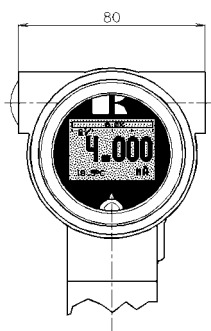

Graphic display with backlight and unique One Touch Programming button

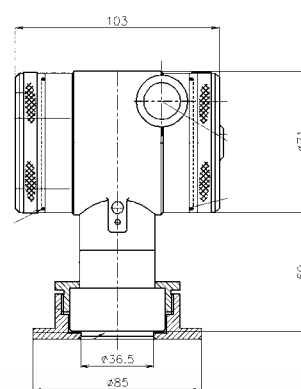

4000-SAN - code W85

SERIES 4000-SAN			Ordering code standard transmitter: 4000-SAN -					
(info on page 3)			Ordering code with cable: 4000-SAN-Cable(....m) -					
Adjustable span range:		Max. overpressure (bar)	▲	▲	▲	▲	▲	▲
0 - 0,05	to 0 - 1,2 bar	10	20					
0 - 0,5	to 0 - 10 bar	50	30					
0 - 5	to 0 - 100 bar	200	40					
PROCESS CONNECTIONS:								
- Milk coupling DIN 11851, DN 25 (only ranges 30 and 40), DN 40, DN 50 (all ranges)				M..				
- Hygenic weld-on nipple diam. 85 mm (tank mounting) or diam. 48 mm (pipe mounting) specify W85 or W48				W..				
- Tri-clamp 1 1/2", 2" or 3" (specify)				L..				
- Flange: DN 25, 40, 50 or 80 (DIN) or 1 1/2", 2" or 3" (ANSI) (specify size)				F..				
- Universal adapter E+H				X1				
- 1 1/2" BSP threaded connection				X3				
- Varivent connection (GEA)				X4				
- 2" IDF coupling				X5				
- DRD				X7				
- SMS 1 1/2" or 2" (specify size)				X9				
OPTIONS:								
- Transparent cover, display functions as local indicator.				I				
- Vacuum Ranges (Specify Relative or absolute) Compound ranges available (example -1 / +1 bar)					V			
- High Temperature version with cooling fins. Always specify Process Temperature					HT			
- Intrinsically safe: ATEX II 1 G Ex ia IIC T4 (pending)						Ex		
- HART® Protocol. HART 7 (= Factory setting), (HART 5 also selectable)								H